

Installation and Quick Start Guide

Agilent Technologies PNA Series Network Analyzers



Manufacturing Part Number: E8356-90001

Printed in USA

Print Date: April 2004

Supersedes: November 2003

© Agilent Technologies, Inc. 2002–2004



E8356-90001

Warranty Statement

THE MATERIAL CONTAINED IN THIS DOCUMENT IS PROVIDED “AS IS,” AND IS SUBJECT TO BEING CHANGED, WITHOUT NOTICE, IN FUTURE EDITIONS. FURTHER, TO THE MAXIMUM EXTENT PERMITTED BY APPLICABLE LAW, AGILENT DISCLAIMS ALL WARRANTIES, EITHER EXPRESS OR IMPLIED WITH REGARD TO THIS MANUAL AND ANY INFORMATION CONTAINED HEREIN, INCLUDING BUT NOT LIMITED TO THE IMPLIED WARRANTIES OF MERCHANTABILITY AND FITNESS FOR A PARTICULAR PURPOSE. AGILENT SHALL NOT BE LIABLE FOR ERRORS OR FOR INCIDENTAL OR CONSEQUENTIAL DAMAGES IN CONNECTION WITH THE FURNISHING, USE, OR PERFORMANCE OF THIS DOCUMENT OR ANY INFORMATION CONTAINED HEREIN. SHOULD AGILENT AND THE USER HAVE A SEPARATE WRITTEN AGREEMENT WITH WARRANTY TERMS COVERING THE MATERIAL IN THIS DOCUMENT THAT CONFLICT WITH THESE TERMS, THE WARRANTY TERMS IN THE SEPARATE AGREEMENT WILL CONTROL.

DFARS/Restricted Rights Notice

If software is for use in the performance of a U.S. Government prime contract or subcontract, Software is delivered and licensed as “Commercial computer software” as defined in DFAR 252.227-7014 (June 1995), or as a “commercial item” as defined in FAR 2.101(a) or as “Restricted computer software” as defined in FAR 52.227-19 (June 1987) or any equivalent agency regulation or contract clause. Use, duplication or disclosure of Software is subject to Agilent Technologies’ standard commercial license terms, and non-DOD Departments and Agencies of the U.S. Government will receive no greater than Restricted Rights as defined in FAR 52.227-19(c)(1-2) (June 1987). U.S. Government users will receive no greater than Limited Rights as defined in FAR 52.227-14 (June 1987) or DFAR 252.227-7015 (b)(2) (November 1995), as applicable in any technical data.

Certification

Agilent Technologies, Inc. certifies that this product met its published specifications at the time of shipment from the factory. Agilent Technologies, Inc. further certifies that its calibration measurements are traceable to the United States National Institute of Standards and Technology, to the extent allowed by the Institute's calibration facility, and to the calibration facilities of other International Standards Organization members.

Assistance

Product maintenance agreements and other customer assistance agreements are available for Agilent Technologies, Inc. products. For information about these agreements and for other assistance, contact Agilent. Refer to [“Contacting Agilent Technologies” on page 2-2](#).

Technology Licenses

The hardware and / or software described in this document are furnished under a license and may be used or copied only in accordance with the terms of such license.

Trademarks

Microsoft is a U.S. registered trademark of Microsoft Corporation. Windows and MS Windows are U.S. registered trademarks of Microsoft Corporation.

Safety Notes

The following safety notes are used throughout this manual. Familiarize yourself with each of the notes and its meaning before operating this instrument. All pertinent safety notes for using this product are located in [Chapter 3 , “Safety and Regulatory Information.”](#)

WARNING	Warning denotes a hazard. It calls attention to a procedure which, if not correctly performed or adhered to, could result in injury or loss of life. Do not proceed beyond a warning note until the indicated conditions are fully understood and met.
----------------	---

CAUTION	Caution denotes a hazard. It calls attention to a procedure that, if not correctly performed or adhered to, could result in damage to or destruction of the instrument. Do not proceed beyond a caution sign until the indicated conditions are fully understood and met.
----------------	---

Documentation Map

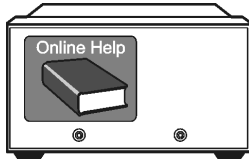

The online Help files are embedded in the analyzer, offering quick reference to programming and user documentation. From the Help drop-down menu, you can access the Help system in six different languages. Also, you can view the Analyzer Product Overview multimedia presentation and access the analyzer's Web page.

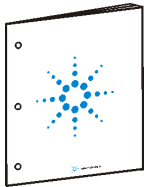

The *Installation and Quick Start Guide* helps to quickly familiarize yourself with the analyzer. Procedures are provided for installing, configuring, and verifying the operation of the analyzer.



The **CD-ROM** provides the following:

- *Installation and Quick Start Guide*
- *Service Guide*
- Help system in five languages
- Network Analyzer Product Overview multimedia presentation

Printing Copies of Documentation from the Web

To print copies of documentation from the Web, download the PDF file from the Agilent web site:

- Go to <http://www.agilent.com>.
- Enter the document's part number (located on the title page) in the **Quick Search** box.
- Click GO.

Contents

1. Installing Your Analyzer

STEP 1. Check the Shipment	1-1
STEP 2. Meet Electrical and Environmental Requirements	1-4
STEP 3. Install the Analyzer on a Bench Top or in an Equipment Rack	1-5
To Install on a Bench Top	1-5
To Install in an Equipment Rack	
(Optional 1CP - Rack Mounting with Handles)	
(Optional 1CM - Rack Mounting without Handles)	1-5
STEP 4. Connect the Accessories	1-6
STEP 5. Install Ferrite Cores	1-7
STEP 6. Start Up the Analyzer	1-8
STEP 7. Perform Administrative Tasks	1-9
STEP 8. Run the Operator's Check	1-10
STEP 9. Turn Off the Analyzer	1-10
To Hibernate the Analyzer	1-10
To Shut Down the Analyzer	1-11

2. Getting Help with Your Analyzer

Help System	2-1
PNA on the Internet	2-1
Contacting Agilent Technologies	2-2

3. Safety and Regulatory Information

Maintenance	3-1
Shipment for Service	3-1
Safety Symbols	3-1
General Safety Considerations	3-2
Safety Earth Ground	3-2
Before Applying Power	3-2
Servicing	3-3
Regulatory Information	3-3
Instructions for Use	3-3
Instrument Markings	3-5
Declaration of Conformity	3-5
Compliance with German Noise Requirements	3-6
Warranty	3-6

1 Installing Your Analyzer

STEP 1. Check the Shipment

<p>1. Unpack the contents of the shipping container. (Keep the packaging material in case the analyzer needs to be returned to the factory.)</p>
<hr/>
<p>WARNING The network analyzer is heavy. Use proper lifting techniques.</p>
<hr/>
<p>2. Carefully inspect the analyzer to make sure that it was not damaged during shipment.</p>
<hr/>
<p>NOTE If your analyzer was damaged during shipment, contact Agilent Technologies. A list of contacts is provided on page 2-2.</p>
<hr/>

3. Locate the Contents List in the shipping container and verify the completeness of your shipment. Although the Contents List is the most accurate, you can also use the following illustration to verify the items in your shipment. If your shipment is not complete, contact Agilent Technologies. A list of contacts is provided on [page 2-2](#).

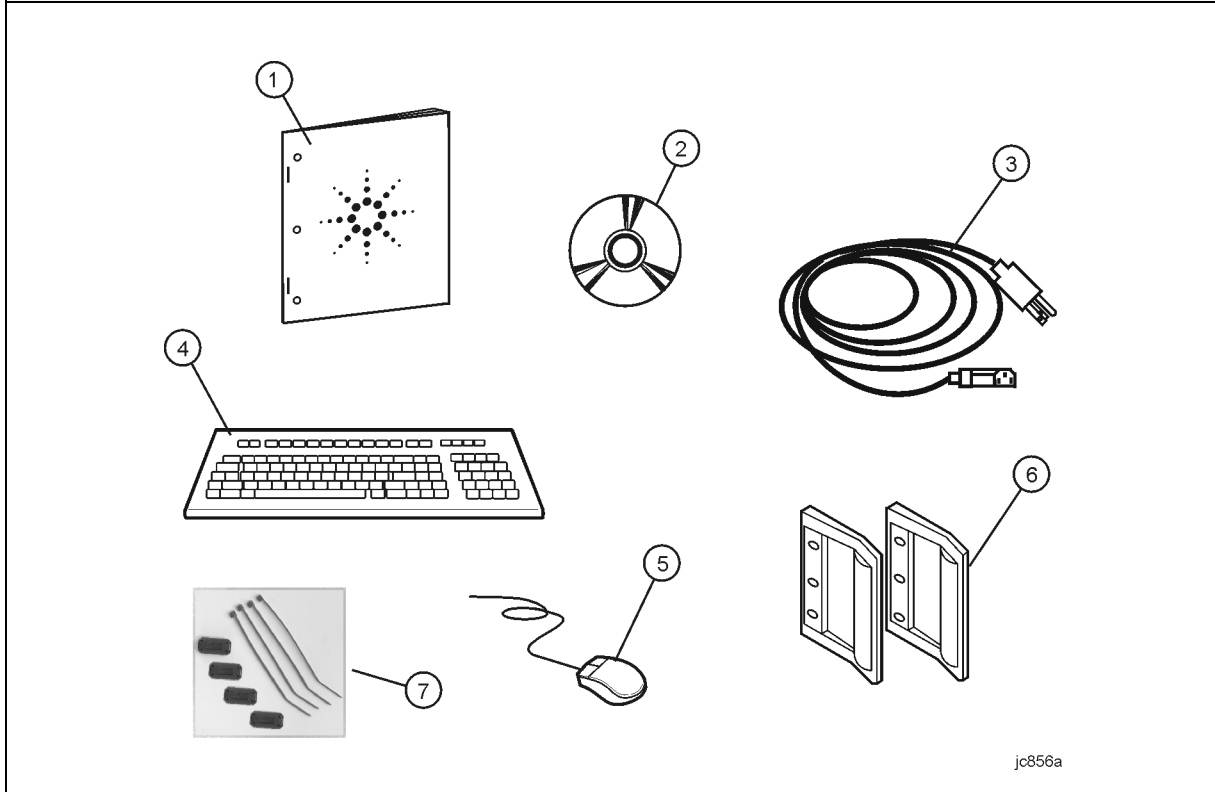

Item Number	Part Number	Part Description
1	E8356-90001	Installation and Quick Start Guide (this document)
2	E8356-10001	PNA Series Network Analyzer Documentation CD-ROM
3	Unique to country	AC Power Cord
4	not applicable ^a	USB Keyboard (English only)
5	not applicable ^a	USB Mouse
6	5063-9229	Front Handle Kit, RF-Frequency Model
	5063-9230	Front Handle Kit, Microwave-Frequency Model
7	not applicable	Ferrite cores and cable ties (refer to “STEP 5. Install Ferrite Cores” on page 1-7)

a. See the Contents List in the shipping container for the current part number.

NOTE A parallel port adapter, part number 1253-4226, was included with early versions of the PNA. This adapter is no longer necessary.

4. If you ordered any of the following options, check the parts. Option 1CM or 1CP (item numbers 1 or 2, below) are shipped in a separate container.

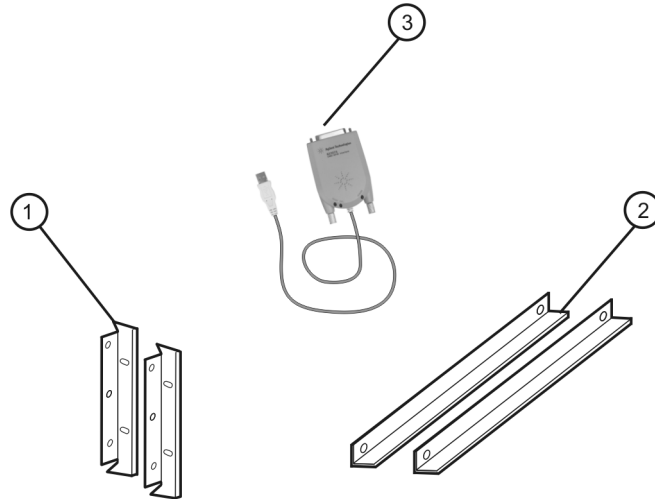

jc853a

Item Number	Option Number	Part Description
1	1CM	Rack Mount Flange Kit (For use without handles)
2		Rack Mount Rail Set
1	1CP	Rack Mount Flange Kit (For use with handles)
2		Rack Mount Rail Set
3	82375A	USB/GPIB Interface (included with Option 083 only)

STEP 2. Meet Electrical and Environmental Requirements

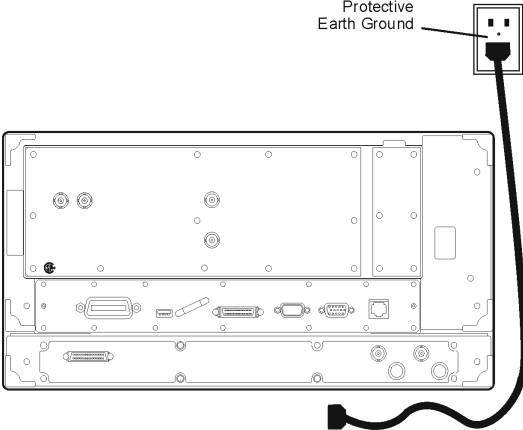
<p>1. Ensure the available AC power source meets the following requirements:</p>	<p>2. Ensure the operating environment meets the following requirements:</p>
<p>CAUTION This instrument has autoranging line voltage input. Be sure the supply voltage is within the specified range.</p> <hr/> <p>The specified range for the power requirements is:</p> <ul style="list-style-type: none"> • 90 – 132 V_{AC} • 48 – 66 Hz / 400 Hz (single phase) <p>- or -</p> <ul style="list-style-type: none"> • 198 – 264 V_{AC} • 48 – 66 Hz (single phase) <p>The instrument power consumption is 600 VA maximum.</p>	<ul style="list-style-type: none"> • 0 to 40 °C • 5% to 95% relative humidity at 40 °C (non-condensing) • 0 to 4,500 meters (0 to 14,760 feet) altitude <hr/> <p>NOTE Some analyzer performance parameters are specified for 25 °C. Later, you can refer to the Help system in the analyzer for the complete specifications.</p>
<p>3. Verify that the AC power cable is not damaged, and that the power-source outlet provides a protective earth contact.</p>	
<div style="text-align: center;">  </div>	
<p>CAUTION Always use the three-prong AC power cord supplied with this product. Failure to ensure adequate earth grounding by not using this cord may cause product damage.</p>	

STEP 3. Install the Analyzer on a Bench Top or in an Equipment Rack

IMPORTANT Please review all safety information located in [Chapter 3](#), “[Safety and Regulatory Information](#)” before proceeding with installing and using the analyzer.

The analyzer can be installed on a bench top or in an equipment rack. When installing the analyzer in an equipment rack, the analyzer can be set up with handles (option 1CP) or without handles (option 1CM).

In all installations, consider the following ventilation requirements when deciding where to set up your analyzer.

CAUTION **Ventilation Requirements:** When installing the product in a cabinet, the convection into and out of the product must not be restricted. The ambient temperature (outside the cabinet) must be less than the maximum operating temperature of the instrument by 4 °C× for every 100 watts dissipated in the cabinet. If the total power dissipated in the cabinet is greater than 800 watts, then forced convection must be used.

Refer to the section, listed below, that applies to your installation.

- **For bench top installation**, continue on [page 1-5](#).
- **For equipment rack installation**, continue on [page 1-5](#).

To Install on a Bench Top

When you install the analyzer for bench top use, you may wish to attach the supplied handles to the analyzer.

If you wish to install the handles, follow the instructions provided with the handle kit.

To Install in an Equipment Rack (Option 1CP - Rack Mounting with Handles) (Option 1CM - Rack Mounting without Handles)

When you install the analyzer in an equipment rack, you must install rails in the rack to support the weight of the analyzer, attach the rack mount flanges (with or without handles) to the analyzer, and secure the analyzer to the equipment rack.

For installation, follow the instructions provided with the rack mount kit and the rail kit.

STEP 4. Connect the Accessories

You can connect several USB accessories to the PNA. Some PNA models have a four-port USB hub mounted internally and accessible through the rear panel. Other PNA models have two USB ports: one on the front panel and one on the rear panel. You can also use an optional USB Hub (model N4689) to increase the available USB ports on the PNA.

USB devices, including the optional hub, can be connected to any available USB port. The PNA will recognize the USB device when it is connected, and run the appropriate software driver to make the device operate correctly.

The following is a list of USB devices commonly used with the PNA. Some of these devices may require additional installation. Refer to the Help that is embedded in the PNA for more information.

- Mouse — standard
- Keyboard — standard
- Read/Write CD-ROM drive (separate product)
- USB Hub (separate product)
- Electronic Calibration (ECal) Modules (separate product)
- Printer (separate product)
- 82357A USB/GPIB Interface — supplied with Option 083

STEP 5. Install Ferrite Cores

CISPR 11 is an international regulation that specifies the maximum level of frequency emissions that can originate from an electronic device. The regulation is designed to minimize the interference that one electronic device may have with another.

Frequency emissions can occur when cables are connected to an electronic device. To minimize this, try to use high-quality cables with built-in molded ferrite cores, with the core closest to the PNA. If cables with built-in cores cannot be found, use one of the clamp-on ferrite cores that are included with the PNA.

It is especially important to use these cores on cables that are connected to the following PNA connectors:

- Parallel Port (rear panel)
- Serial Port (rear panel)
- VGA (rear panel)
- Probe power (front panel)

The core should snap closed to grip the cable firmly, but without damaging the cable. Attach the core to the cable as close as possible to the PNA connector end. Cable ties are included to help ensure that the ferrite cores remain in place.

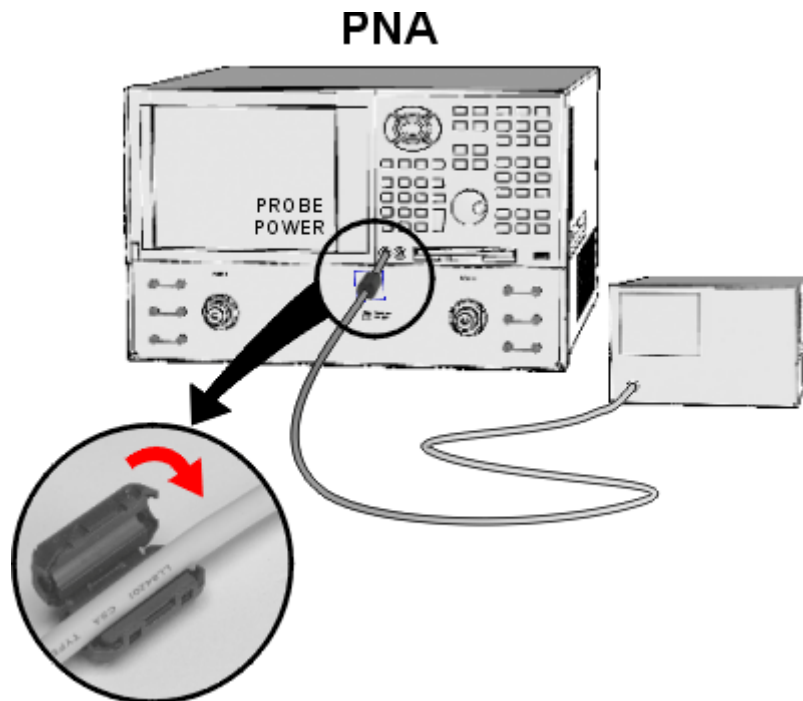

STEP 6. Start Up the Analyzer

CAUTION Install the instrument so that the detachable power cord is readily identifiable and is easily reached by the operator. The detachable power cord is the instrument disconnecting device. It disconnects the mains circuits from the mains supply before other parts of the instrument. The front panel switch is only a standby switch and is not a **LINE** switch. Alternatively, an externally installed switch or circuit breaker (which is readily identifiable and is easily reached by the operator) may be used as a disconnecting device.

1. Connect the AC power cable.

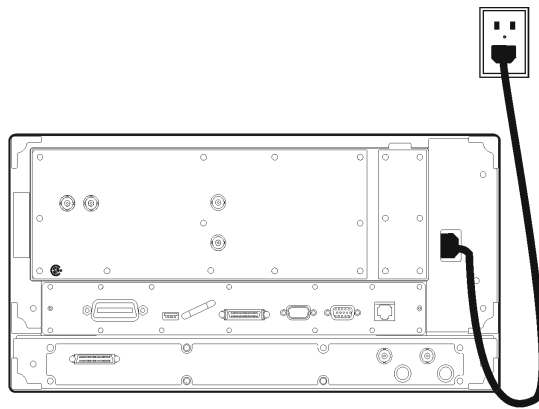

jc810a

2. Turn the analyzer on by pressing the front panel On/Off switch. When the analyzer is turned on, the On/Off switch changes color from yellow to green.

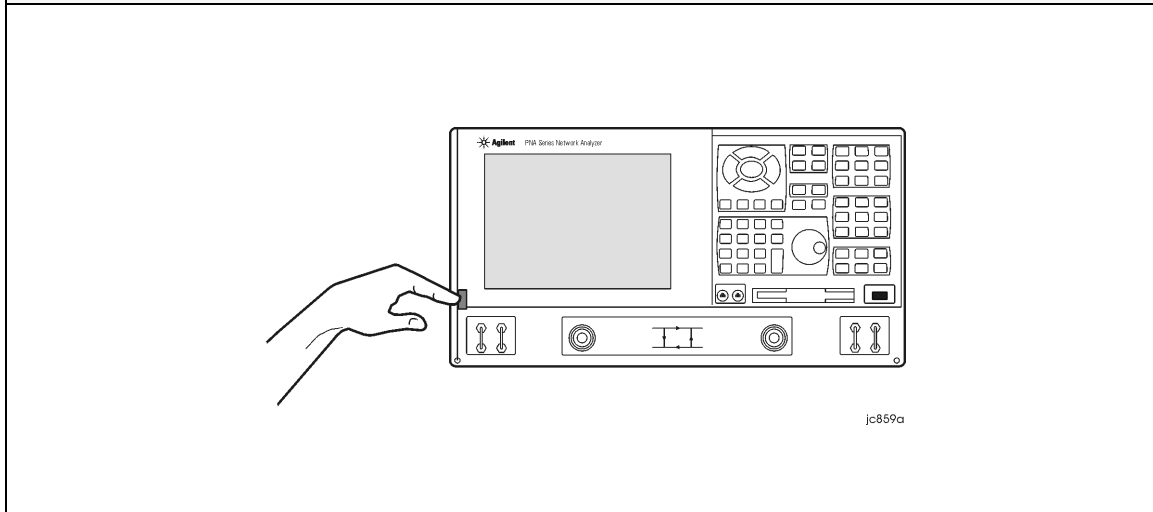

NOTE The Agilent PNA Series Network Analyzer is a network analyzer that operates on a personal computer (PC) platform with Microsoft® Windows® as the operating system.

The first time you start the PNA, the Microsoft® Windows® license agreement is presented. Click **I Accept**, then **Next**.

STEP 7. Perform Administrative Tasks

IMPORTANT The basic Windows configuration and software shipped with the PNA should *not* be modified. This includes the addition or deletion of any hard-disk drive partitions, the deletion of the “Agilent” user profile, or the modification of any of the Agilent registry entries. Problems that result from modifications will *not* be covered under warranty. For more information, type the keywords **Windows** in the index of the Help system in the analyzer.

We recommend that you consider performing the following administrative tasks shortly after powering up the analyzer for the first time.

- Set up analyzer users
- Set up the administrator password
- Enter the computer name
- Set the time and date
- Select a local language for the help system (default is English)

Procedures for the above tasks are in the Help system in the analyzer. To view these procedures:

- On the analyzer’s front panel, press the **Help** button. Or, on the PNA display, click **Help**,

STEP 8. Run the Operator's Check

Network Analyzer Help.

- Click **Quick Start** in PNA Help.
- Click **Perform Administrative Tasks**.
- Click the task you wish to perform.



STEP 8. Run the Operator's Check

The operator's check should be performed when you first receive your analyzer, and any time you wish to have confidence that the analyzer is working properly. The operator's check does not verify performance to specifications, but should give you a high degree of confidence that the instrument is performing properly.

On the **System** menu, point to **Service**, and then click **Operator's Check**. Follow the prompts.

For assistance, use the **Help** button displayed on the screen of the Operator's Check.

STEP 9. Turn Off the Analyzer

The following two modes are used to turn off the analyzer:

- hibernate
- shut down

To Hibernate the Analyzer

There are two methods to hibernate the analyzer:

- Method 1: Press the front panel On/Off switch momentarily.
 - Do not hold down the switch.
 - Do not repeatedly press the switch.
- Method 2: Click **Start, Shutdown**. In the dialog box, select **Hibernate**.

Within a few seconds, two banners are displayed momentarily. (The first banner states "Preparing to Hibernate". The second banner states "Hibernating".) The current analyzer state is saved to the analyzer's hard disk.

The On/Off switch color changes from green to yellow when the analyzer has finished switching to hibernation state.

When the analyzer is in the hibernation state, pressing the On/Off switch wakes up the analyzer. The analyzer application reads the hard disk to load the exact state that the analyzer was in before it was hibernated. This saves time by avoiding a full system boot up.

Powering-up the analyzer after Hibernation mode does not require a password. If security is an important issue and you need password protection, choose the shut down mode to turn off the analyzer.

For more hibernate information, type **hibernate** in the index of the Help system in the

analyzer.

To Shut Down the Analyzer

IMPORTANT Only shut down the analyzer when preparing to service it, or provide security via password protection.

To shut down the analyzer, click **Start, Shutdown**. In the dialog box, select **Shut Down**.

The On/Off switch color changes from green to yellow when the analyzer has finished switching to shut down mode.

When turned on, the analyzer application powers-up in the preset settings after performing a full system boot-up and requesting a password.

CAUTION ***Only in an emergency***, should the power cord be removed from the analyzer without first turning off the analyzer. Removing the power cord without the analyzer in hibernation or shut down mode ***is likely*** to damage the analyzer's hard drive.

Installing Your Analyzer
STEP 9. Turn Off the Analyzer

2 Getting Help with Your Analyzer

Help System

Use on-line Help to quickly reference programming and user documentation. English, Chinese, French, German, Japanese, and Spanish language versions are available through the Help menu. (Programming information is only available in English.)

We recommend that you begin by accessing Help and reading the topics in the Quick Start section. To access this information:

- On the analyzer's front panel, press the **Help** button. Or, on the PNA display, click **Help, Network Analyzer Help**.
- Click **Quick Start** in PNA Help.



PNA on the Internet

The PNA Series Network Analyzer System Web page is another resource for help with the analyzer. This Web page has links to information about equipment and literature related to PNA series network analyzers. You can visit the Agilent Technologies web site where you can find product information, service notes, training information, application notes, online manuals, and other information. To access the PNA Series Network Analyzer System Web page:

- Click **Help**.
 - Or, on the analyzer's front panel, press **Menu/Dialog**. Next, in the **NAVIGATION BLOCK**, press the Left Tab several times to move to **Help**.
- Click **Network Analyzer on the Web**.

Contacting Agilent Technologies

Online assistance: www.agilent.com/find/assist			
Americas			
Brazil (tel) (+55) 11 4197 3600 (fax) (+55) 11 4197 3800	Canada (tel) 877 894 4414 (fax) (+1) 905 282-6495	Mexico (tel) (+52) 55 5081 9469 (alt) 01800 5064 800 (fax) (+52) 55 5081 9467	United States (tel) 800 829 4444 (alt) (+1) 303 662 3998 (fax) 800 829 4433
Asia Pacific and Japan			
Australia (tel) 1800 629 485 (alt) 1800 143 243 (fax) 1800 142 134	China (tel) 800 810 0189 (alt) (+86) 10800 650 0021 (fax) 800 820 2816	Hong Kong (tel) 800 930 871 (alt) (+852) 3197 7889 (fax) (+852) 2 506 9233	India (tel) 1600 112 929 (fax) 000800 650 1101
Japan (tel) 0120 421 345 (alt) (+81) 426 56 7832 (fax) 0120 421 678	Malaysia (tel) 1800 888 848 (alt) 1800 828 848 (fax) 1800 801 664	Singapore (tel) 1800 375 8100 (alt) (+65) 6 375 8100 (fax) (+65) 6836 0252	South Korea (tel) 080 769 0800 (alt) (+82) 2 2004 5004 (fax) (+82) 2 2004 5115
Taiwan (tel) 0800 047 866 (alt) 00801 651 317 (fax) 0800 286 331	Thailand (tel) 1800 226 008 (alt) (+66) 2 268 1345 (fax) (+66) 2 661 3714		
Europe			
Austria (tel) 0820 87 44 11* (fax) 0820 87 44 22	Belgium (tel) (+32) (0)2 404 9340 (alt) (+32) (0)2 404 9000 (fax) (+32) (0)2 404 9395	Denmark (tel) (+45) 7013 1515 (alt) (+45) 7013 7313 (fax) (+45) 7013 1555	Finland (tel) (+358) 10 855 2100 (fax) (+358) 10 855 2923
France (tel) 0825 010 700* (alt) (+33) (0)1 6453 5623 (fax) 0825 010 701*	Germany (tel) 01805 24 6333* (alt) 01805 24 6330* (fax) 01805 24 6336*	Ireland (tel) (+353) (0)1 890 924 204 (alt) (+353) (0)1 890 924 206 (fax) (+353) (0)1 890 924 024	Israel (tel) (+972) 3 9288 500 (fax) (+972) 3 9288 501
Italy (tel) (+39) (0)2 9260 8484 (fax) (+39) (0)2 9544 1175	Luxemburg (tel) (+32) (0)2 404 9340 (alt) (+32) (0)2 404 9000 (fax) (+32) (0)2 404 9395	Netherlands (tel) (+31) (0)20 547 2111 (alt) (+31) (0)20 547 2000 (fax) (+31) (0)20 547 2190	Russia (tel) (+7) 095 797 3963 (alt) (+7) 095 797 3900 (fax) (+7) 095 797 3901
Spain (tel) (+34) 91 631 3300 (alt) (+34) 91 631 3000 (fax) (+34) 91 631 3301	Sweden (tel) 0200 88 22 55* (alt) (+46) (0)8 5064 8686 (fax) 020 120 2266*	Switzerland (French) (tel) 0800 80 5353 opt. 2* (alt) (+33) (0)1 6453 5623 (fax) (+41) (0)22 567 5313	Switzerland (German) (tel) 0800 80 5353 opt. 1* (alt) (+49) (0)7031 464 6333 (fax) (+41) (0)1 272 7373
Switzerland (Italian) (tel) 0800 80 5353 opt. 3* (alt) (+39) (0)2 9260 8484 (fax) (+41) (0)22 567 5314	United Kingdom (tel) (+44) (0)7004 666666 (alt) (+44) (0)7004 123123 (fax) (+44) (0)7004 444555		
(tel) = primary telephone number; (alt) = alternate telephone number; (fax) = FAX number; * = in country number			

3 Safety and Regulatory Information

Maintenance

To remove dirt or dust from the external case of the network analyzer, clean the case using a dry or slightly-dampened cloth only.

WARNING **To prevent electrical shock, disconnect analyzer from mains before cleaning. Use a dry cloth or one slightly dampened with water to clean the external case parts. Do not attempt to clean internally.**

Shipment for Service

Contact Agilent Technologies for instructions on where to ship the analyzer for service. Refer to [page 2-2](#) for a list of Agilent Technologies contacts.

Ship the analyzer using the original packaging materials. Shipping the analyzer in anything other than the original packaging may result in non-warranted damage.

Safety Symbols

The following safety symbols are used throughout this manual. Familiarize yourself with each of the symbols and its meaning before operating this instrument.

CAUTION Caution denotes a hazard. It calls attention to a procedure that, if not correctly performed or adhered to, would result in damage to or destruction of the product. Do not proceed beyond a caution note until the indicated conditions are fully understood and met.

WARNING **Warning denotes a hazard. It calls attention to a procedure which, if not correctly performed or adhered to, could result in injury or loss of life. Do not proceed beyond a warning note until the indicated conditions are fully understood and met.**

General Safety Considerations

Safety Earth Ground

WARNING This is a Safety Class I Product (provided with a protective earthing ground incorporated in the power cord). The mains plug shall only be inserted in a socket outlet provided with a protective earth contact. Any interruption of the protective conductor, inside or outside the product, is likely to make the product dangerous. Intentional interruption is prohibited.

CAUTION Always use the three-prong AC power cord supplied with this product. Failure to ensure adequate earth grounding by not using this cord may cause product damage.

Before Applying Power

WARNING If this product is not used as specified, the protection provided by the equipment could be impaired. This product must be used in a normal condition (in which all means for protection are intact) only.

WARNING If an instrument handle is damaged, you should replace it immediately. Damaged handles can break while you are moving or lifting the instrument and cause personal injury or damage to the instrument.

CAUTION This instrument has autoranging line voltage input. Be sure the supply voltage is within the specified range.

CAUTION This product is designed for use in Installation Category II and Pollution Degree 2 per IEC 61010 and 664 respectively.

CAUTION **Ventilation Requirements:** When installing the product in a cabinet, the convection into and out of the product must not be restricted. The ambient temperature (outside the cabinet) must be less than the maximum operating temperature of the instrument by 4 °C× for every 100 watts dissipated in the cabinet. If the total power dissipated in the cabinet is greater than 800 watts, then forced convection must be used.

CAUTION The measuring terminals on this instrument are designed to be used with external signals described in Measurement Category I, but NOT with external signals described in Categories II, III, and IV. The input of this instrument cannot be connected to the mains.

Servicing

WARNING **These servicing instructions are for use by qualified personnel only. To avoid electrical shock, do not perform any servicing unless you are qualified to do so.**

WARNING **No operator serviceable parts inside. Refer servicing to qualified personnel. To prevent electrical shock, do not remove covers.**

WARNING **The opening of covers or removal of parts is likely to expose dangerous voltages. Disconnect the product from all voltage sources while it is being opened.**

WARNING **The power cord is connected to internal capacitors that may remain live for 5 seconds after disconnecting the plug from its power supply.**

Regulatory Information

This section contains information that is required by various government regulatory agencies.

Instructions for Use

This product has been designed and tested in accordance with the standards listed on the Manufacturer's Declaration of Conformity, and has been supplied in a safe condition. The documentation contains information and warnings that must be followed by the user to ensure safe operation and to maintain the product in a safe condition.

Install the instrument so that the detachable power cord is readily identifiable and is easily reached by the operator.

The detachable power cord is the instrument disconnecting device. It disconnects the mains circuits from the mains supply before other parts of the instrument. **The front panel switch is only a standby switch and is not a LINE switch (disconnecting**

device).

Alternatively, an externally installed switch or circuit breaker (which is readily identifiable and is easily reached by the operator) may be used as a disconnecting device.

Instrument Markings



The instruction documentation symbol. The product is marked with this symbol when it is necessary for the user to refer to the instructions in the documentation.



The CE mark is a registered trademark of the European Community. (If accompanied by a year, it is when the design was proven.)



The CSA mark is a registered trademark of the Canadian Standards Association.

ICES/NMB-001

This ISM device complies with Canadian ICES-001.
Cet appareil ISM est conforme a la norme NMB-001 du Canada.

ISM1-A

This is a symbol of an Industrial Scientific and Medical Group 1 Class A product.



This is a required mark signifying compliance with an EMC requirement. The C-Tick mark is a registered trademark of the Australian Spectrum Management Agency.

The ON, OFF, and STANDBY symbols are used to mark the positions of the instrument power line switch. The AC symbol is used to indicate the required nature of the line module input power.



ON symbol



ON symbol



STANDBY symbol



OFF symbol



OFF symbol



AC (alternating current) symbol

Declaration of Conformity

A declaration of conformity is on file for the PNA models, and a copy is available upon request.

Compliance with German Noise Requirements

This is to declare that this instrument is in conformance with the German Regulation on Noise Declaration for Machines (Laermangabe nach der Maschinenlaermrrerordnung –3.GSGV Deutschland).

Acoustic Noise Emission/Geraeuschemission	
LpA<70 dB	Lpa<70 dB
Operator Position	am Arbeitsplatz
Normal Operation	normaler Betrieb
per ISO 7779	nach DIN 45635 t. 19

Warranty

The actual warranty on your instrument depends on the date it was ordered as well as whether or not any warranty options were purchased at that time. To determine the exact warranty on your instrument, contact Agilent Technologies with the model and serial number of your instrument. See [page 2-2](#) for contact information.